





Model Code: LT100X

Included Accessories

		
ICM	UMG	6020

Optional Accessories

Dimensions

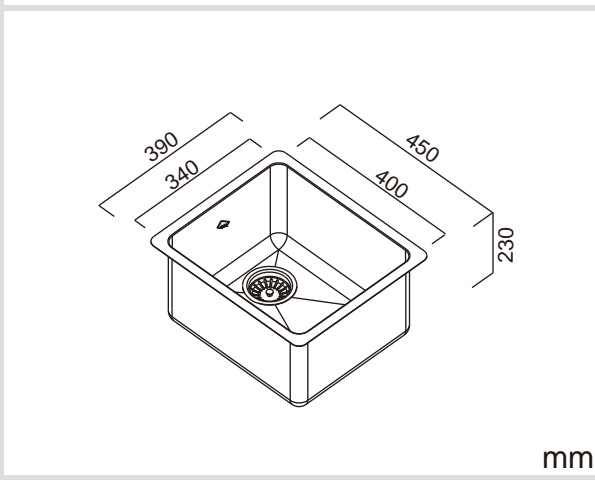

Specifications

Description	Single bowl, inset & Undermount sink
Overall Sink Size	390mm x 450mm x 230mm deep
Bowl Dimensions	340mm x 400mm x 230mm deep
Drainer Length	N/A
Technic	Handcrafted
Volumes	31L
Material	Stainless steel SUS304

Installation

Fixings	Inset clips supplied & Undermount
Template	N/A
Min Cabinet Size	500mm
Waste Holes	1 x 90mm round Compatible with waste disposal
Sealing Strip	Factory fitted

Plumbing

Waste Fittings	1 x (90mm x 2") basket waste included
Overflow	Available, conditions apply

Packaging

Carton Type	EPS protection & carton
Gross Weight	4.8Kg
Carton Size	460mm x 320mm x 513mm
Pack QTY	1

SURFACE FINISH



WASTE KIT

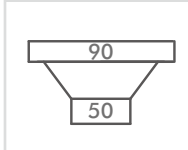

MATERIAL



INSTALLATION OPTIONS

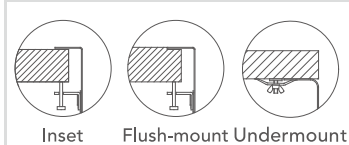

PROFILE

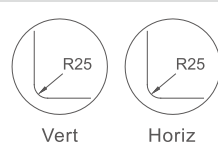

Abey are Australia's leaders in sinkware, designing and manufacturing to the world's highest quality specifications as well as sourcing and bringing you Europe's very best, leading edge designs – practical, affordable, inspirational, stylish, timeless or cutting edge. When you buy an Abey stainless steel sink you receive the highest quality and 25 year warranty. Abey and the manufacturer are continually seeking ways to improve the design specifications, aesthetic and production techniques of the products. As a result, alterations to the specifications and dimensions of the products and designs occur continually.