

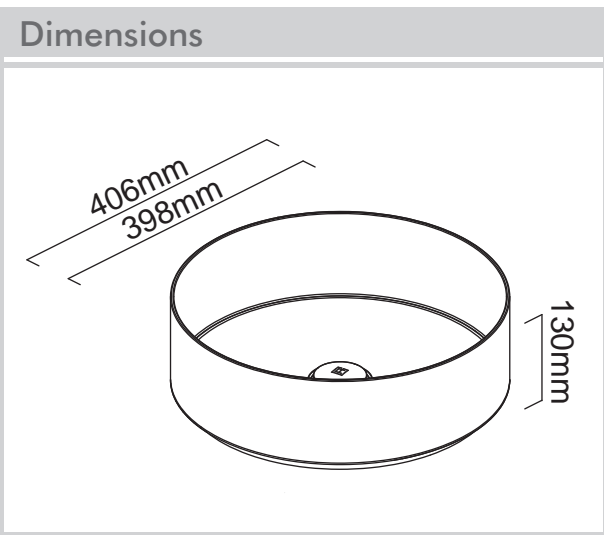

Model Code: 304RND

Included Accessories		
		
304VBW		

Optional Accessories		





Specifications

Description	Single Bowl
Overall Sink Size	406mm x 406mm x 130mm deep
Bowl Dimensions	398mm x 398mm x 113mm deep
Drainer Length	N/A
Technic	Fabrication
Material	Stainless steel SUS304

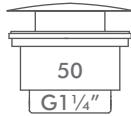

Installation

Fixings	N/A
Template	N/A
Min Cabinet Size	N/A
Waste Holes	1 x 52mm round

<h4>SURFACE FINISH</h4>  <p>Brush Satin</p>	<h4>WASTE KIT</h4>  <p>50 G1 1/4"</p>	<h4>MATERIAL</h4>  <p>SUS 304 Stainless Steel</p>
--	--	--

Plumbing

Waste Fittings	1 x (52mm x 1 1/4") cover waste included
Overflow	N/A

<h4>INSTALLATION OPTIONS</h4> 	<h4>PROFILE</h4>  <p>R0 Vert</p>
---	---

Packaging

Carton Type	EPS protection
Gross Weight	6.33Kg
Carton Size	495mm x 210mm x 495mm
Pack QTY	1

Abey are Australia's leaders in sinkware, designing and manufacturing to the world's highest quality specifications as well as sourcing and bringing you Europe's very best, leading edge designs – practical, affordable, inspirational, stylish, timeless or cutting edge. When you buy an Abey stainless steel sink you receive the highest quality and 25 year warranty. Abey and the manufacturer are continually seeking ways to improve the design specifications, aesthetic and production techniques of the products. As a result, alterations to the specifications and dimensions of the products and designs occur continually.