

Model Code: 304REC-G

Included Accessories		
 304VBW-G		

Optional Accessories		

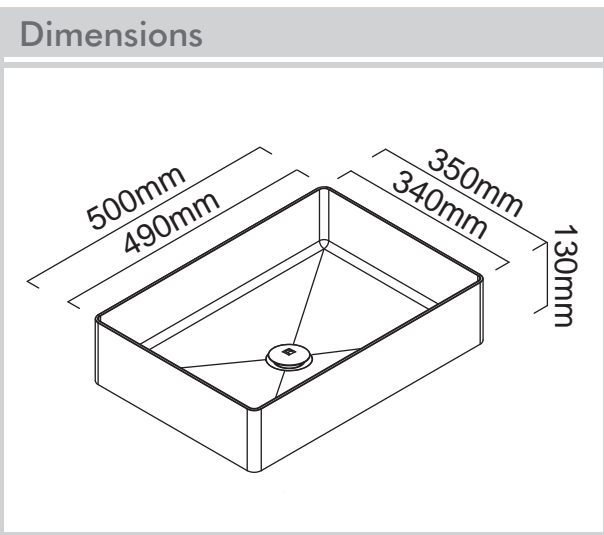



Specifications

Description	Single Bowl
Overall Sink Size	500mm x 350mm x 130mm deep
Bowl Dimensions	490mm x 340mm x 105mm deep
Drainer Length	N/A
Technic	Fabrication
Material	Stainless steel SUS304

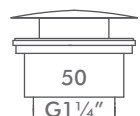

Installation

Fixings	N/A
Template	N/A
Min Cabinet Size	N/A
Waste Holes	1 x 52mm round

<h4>SURFACE FINISH</h4>  <p>Microbrush</p>	<h4>WASTE KIT</h4>  <p>50 G1 1/4"</p>	<h4>MATERIAL</h4>  <p>SUS 304 Stainless Steel</p>
---	--	--

Plumbing

Waste Fittings	1 x (52mm x 1 1/4") cover waste included
Overflow	N/A

<h4>INSTALLATION OPTIONS</h4> 	<h4>PROFILE</h4>  <p>Vert Horiz</p>
---	--

Packaging

Carton Type	EPS protection
Gross Weight	9.51Kg
Carton Size	605mm x 210mm x 460mm
Pack QTY	1

Abey are Australia's leaders in sinkware, designing and manufacturing to the world's highest quality specifications as well as sourcing and bringing you Europe's very best, leading edge designs – practical, affordable, inspirational, stylish, timeless or cutting edge. When you buy an Abey stainless steel sink you receive the highest quality and 25 year warranty. Abey and the manufacturer are continually seeking ways to improve the design specifications, aesthetic and production techniques of the products. As a result, alterations to the specifications and dimensions of the products and designs occur continually.